

PROJECT
TYPE
SPECIFIER
QUANTITY
DATE

## SLIDER STRAIGHT IP54 SUSPENSION

### A300933-

base number	LED Dimming	Color Temperature	Finishes (Diamond)	Finishes (Triangle)	Finishes (Circle)	Cable Length	Diffuser Options
-------------	-------------	-------------------	--------------------	---------------------	-------------------	--------------	------------------

- To build a product code in our configurator select the specify button on the base model # product page
- To build a manual product code on this datasheet choose from the options listed below in blue font and add the suffix to the base model #

#### GENERAL

Series: Slider Straight IP54  
 Partner: Prolicht  
 Division: Architectural  
 Installation: Suspension  
 Product Type: Linear Profiles  
 Mounting Location: Ceiling  
 Light Distribution: Direct

#### PHYSICAL

Shape: Rectangle  
 Length (mm): 1410  
 Length (in): 55 1/2  
 Width (mm): 65  
 Width (in): 2 9/16  
 Height (mm): 80  
 Height (in): 3 1/8  
 Weight (kg): 2.200

Diffuser: Diffuser - Opal, Micro-prism, Clear Micro-prism, Glare Control, Wallwasher Right, Wallwasher Left, Wallwash Double Asymmetric

Fixture Finish: SSR / BKV / CWI / CRY / HAB / UFT / ITA / RUA / FTG / MYG / LOD / PUS / FRO / FUP / KIA / POP / BLS / SPG / MEY / GOH / CHC / COM / ABZ / JAG / OBR / MOS / ROR

Fixture Material: Aluminum Die Cast  
 Cable Details: 2,000mm/78 3/4" or 6,000mm/236 1/4" Transparent Cable

#### ELECTRICAL

Lamp Type: LED (Zhaga Standard)  
 Input Wattage (W): 30  
 Total Output Wattage (W): 27.3  
 Dimming: Non-Dimmable  
 Driver Included: No  
 Driver Location: Remote  
 Driver Class: Class 2  
 Input Voltage (V): 120  
 Upon Request: DALI Dimming, MATTER Dimming

#### LED

Color Temperature (°K): 2700 / 3000 / 3500 / 4000  
 Max. Delivered Lumen (lm): 3097 - 4306  
 Nominal Lumen (lm): 4780 - 4900  
 CRI: >90 CRI  
 Lamp Life (hrs): 50000

#### OPTICAL

#### RATINGS AND CERTIFICATIONS

Certified By: Certified for North American Standards  
 IP rating: IP54

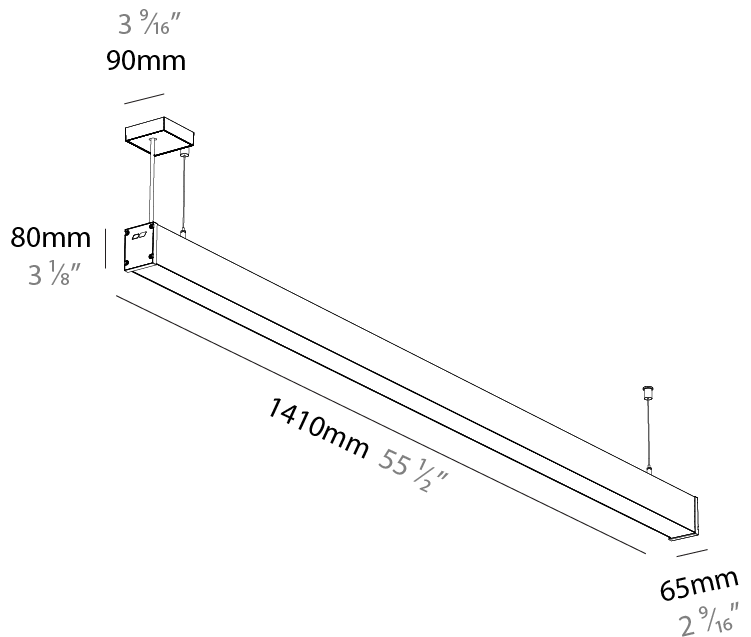

## SLIDER STRAIGHT IP54 SUSPENSION

A300933-

PROJECT \_\_\_\_\_

TYPE \_\_\_\_\_

SPECIFIER \_\_\_\_\_

QUANTITY \_\_\_\_\_

DATE \_\_\_\_\_

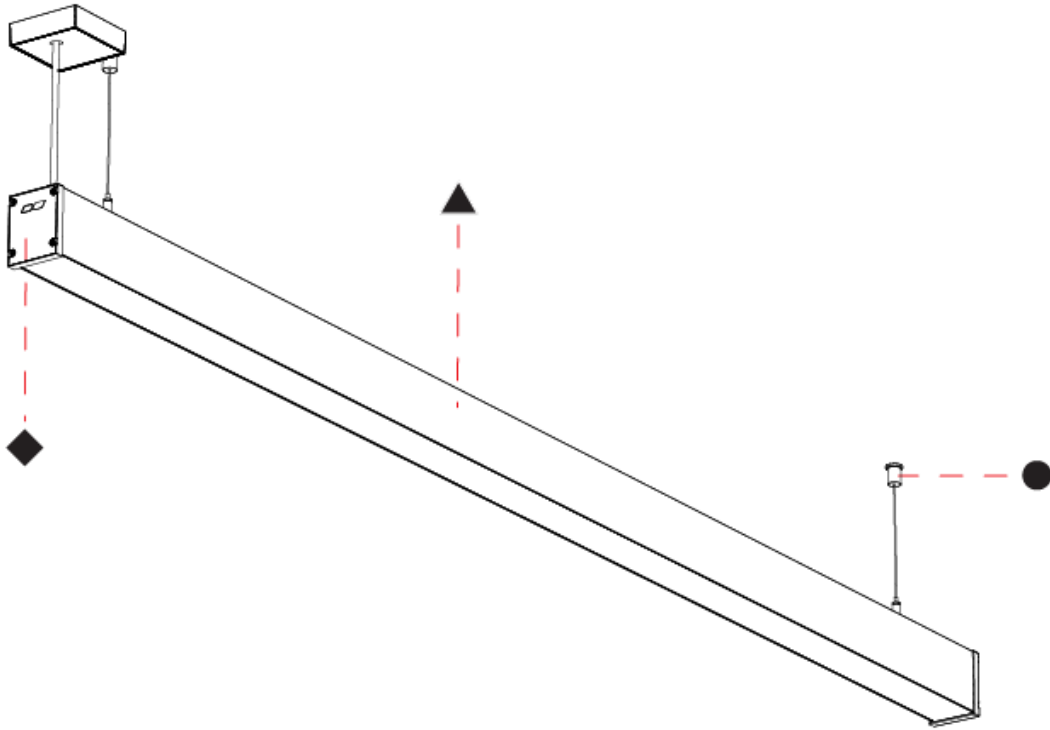

A

PROJECT
TYPE
SPECIFIER
QUANTITY
DATE

## SLIDER STRAIGHT IP54 SUSPENSION

### A300934-

base number	LED	Color	Finishes	Finishes	Finishes	Cable	Diffuser
	Dimming	Temperature	(Diamond)	(Triangle)	(Circle)	Length	Options

- To build a product code in our configurator select the specify button on the base model # product page
- To build a manual product code on this datasheet choose from the options listed below in blue font and add the suffix to the base model #

#### GENERAL

Series: Slider Straight IP54  
 Partner: Prolicht  
 Division: Architectural  
 Installation: Suspension  
 Product Type: Linear Profiles  
 Mounting Location: Ceiling  
 Light Distribution: Direct

#### PHYSICAL

Shape: Rectangle  
 Length (mm): 1410  
 Length (in): 55 1/2  
 Width (mm): 65  
 Width (in): 2 9/16  
 Height (mm): 80  
 Height (in): 3 1/8  
 Weight (kg): 2.200

Diffuser: Diffuser - Opal, Micro-prism, Clear Micro-prism, Glare Control, Wallwasher Right, Wallwasher Left, Wallwash Double Asymmetric

Fixture Finish: SSR / BKV / CWI / CRY / HAB / UFT / ITA / RUA / FTG / MYG / LOD / PUS / FRO / FUP / KIA / POP / BLS / SPG / MEY / GOH / CHC / COM / ABZ / JAG / OBR / MOS / ROR

Fixture Material: Aluminum Die Cast  
 Cable Details: 2,000mm/78 3/4" or 6,000mm/236 1/4" Transparent Cable

#### ELECTRICAL

Lamp Type: LED (Zhaga Standard)  
 Input Wattage (W): 34  
 Total Output Wattage (W): 32.9  
 Dimming: Non-Dimmable  
 Driver Included: No  
 Driver Location: Remote  
 Driver Class: Class 2  
 Input Voltage (V): 120  
 Upon Request: DALI Dimming, MATTER Dimming

#### LED

Color Temperature (°K): 2700 / 3000 / 3500 / 4000  
 Max. Delivered Lumen (lm): 3538 - 4919  
 Nominal Lumen (lm): 5460 - 5700  
 CRI: >90 CRI  
 Lamp Life (hrs): 50000

#### OPTICAL

#### RATINGS AND CERTIFICATIONS

Certified By: Certified for North American Standards  
 IP rating: IP54

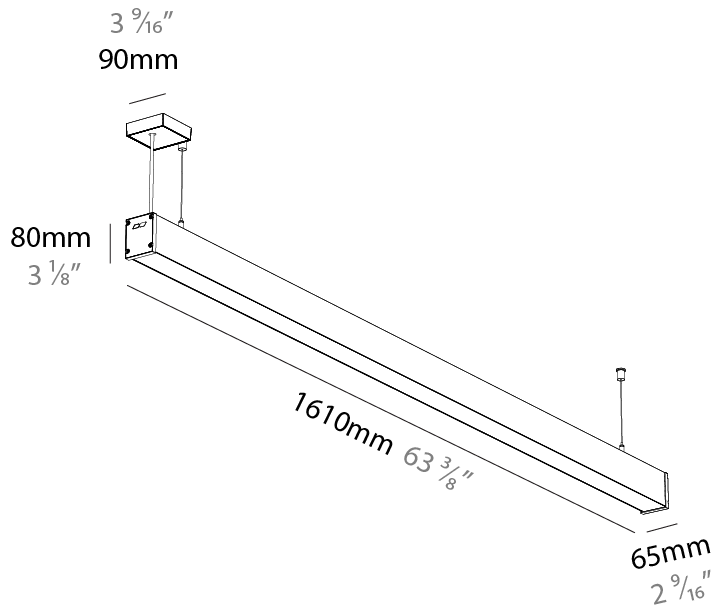

## SLIDER STRAIGHT IP54 SUSPENSION

A300934-

PROJECT
TYPE
SPECIFIER
QUANTITY
DATE

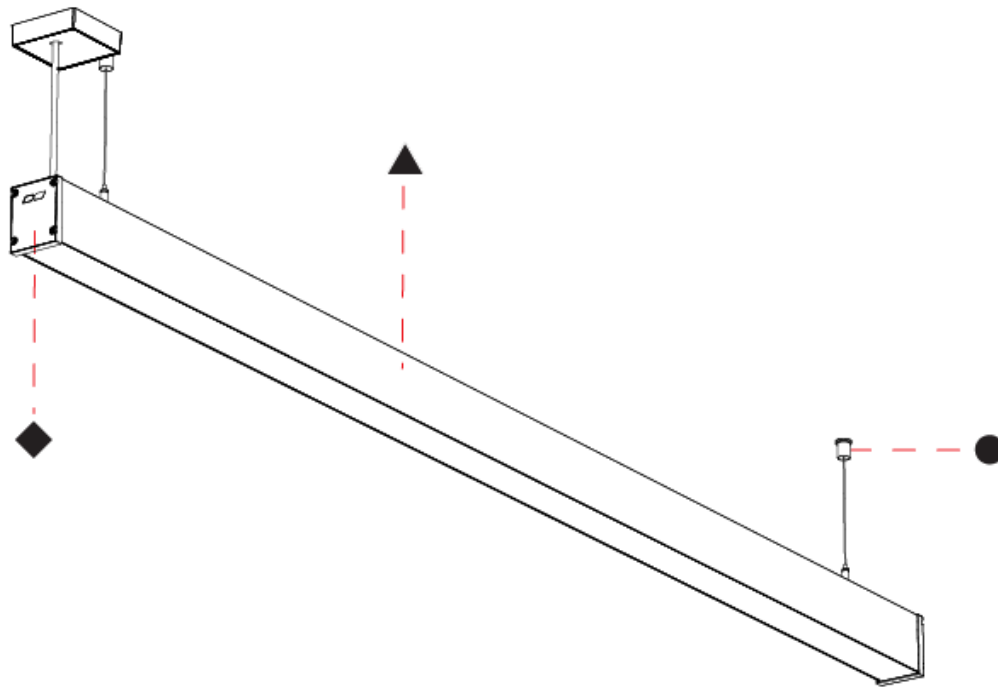

A

PROJECT
TYPE
SPECIFIER
QUANTITY
DATE

## SLIDER STRAIGHT IP54 SUSPENSION

### A300935-

base number	LED	Color	Finishes	Finishes	Finishes	Cable	Diffuser
	Dimming	Temperature	(Diamond)	(Triangle)	(Circle)	Length	Options

- To build a product code in our configurator select the specify button on the base model # product page
- To build a manual product code on this datasheet choose from the options listed below in blue font and add the suffix to the base model #

#### GENERAL

Series: Slider Straight IP54  
 Partner: Prolicht  
 Division: Architectural  
 Installation: Suspension  
 Product Type: Linear Profiles  
 Mounting Location: Ceiling  
 Light Distribution: Direct

#### PHYSICAL

Shape: Rectangle  
 Length (mm): 1810  
 Length (in): 71 1/4  
 Width (mm): 65  
 Width (in): 2 9/16  
 Height (mm): 80  
 Height (in): 3 1/8  
 Weight (kg): 2.200

Diffuser: Diffuser - Opal, Micro-prism, Clear Micro-prism , Glare Control, Wallwasher Right, Wallwasher Left, Wallwash Double Asymmetric

Fixture Finish: SSR / BKV / CWI / CRY / HAB / UFT / ITA / RUA / FTG / MYG / LOD / PUS / FRO / FUP / KIA / POP / BLS / SPG / MEY / GOH / CHC / COM / ABZ / JAG / OBR / MOS / ROR

Fixture Material: Aluminum Die Cast  
 Cable Details: 2,000mm/78 3/4" or 6,000mm/236 1/4" Transparent Cable

#### ELECTRICAL

Lamp Type: LED (Zhaga Standard)  
 Input Wattage (W): 39  
 Total Output Wattage (W): 35.5  
 Dimming: Non-Dimmable  
 Driver Included: No  
 Driver Location: Remote  
 Driver Type: Constant Current - Universal  
 Driver Class: Class 2  
 Input Voltage (V): 120  
 Constant Current (MA): 300  
 Upon Request: DALI Dimming, MATTER Dimming

#### LED

Color Temperature (°K): 2700 / 3000 / 3500 / 4000  
 Max. Delivered Lumen (lm): 3985 - 5540  
 Nominal Lumen (lm): 6150 - 6420  
 CRI: >90 CRI  
 Lamp Life (hrs): 50000

#### OPTICAL

#### RATINGS AND CERTIFICATIONS

Certified By: Certified for North American Standards  
 IP rating: IP54

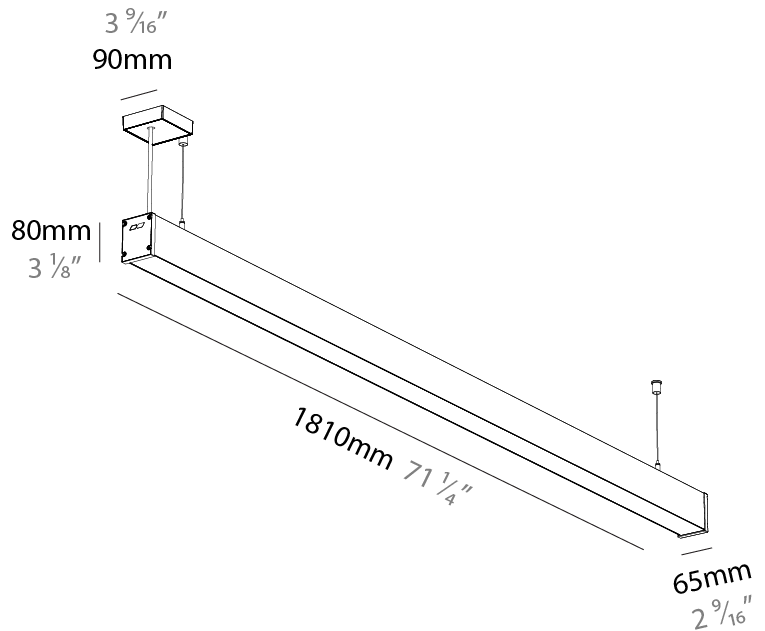

## SLIDER STRAIGHT IP54 SUSPENSION

A300935-

PROJECT	_____
TYPE	_____
SPECIFIER	_____
QUANTITY	_____
DATE	_____

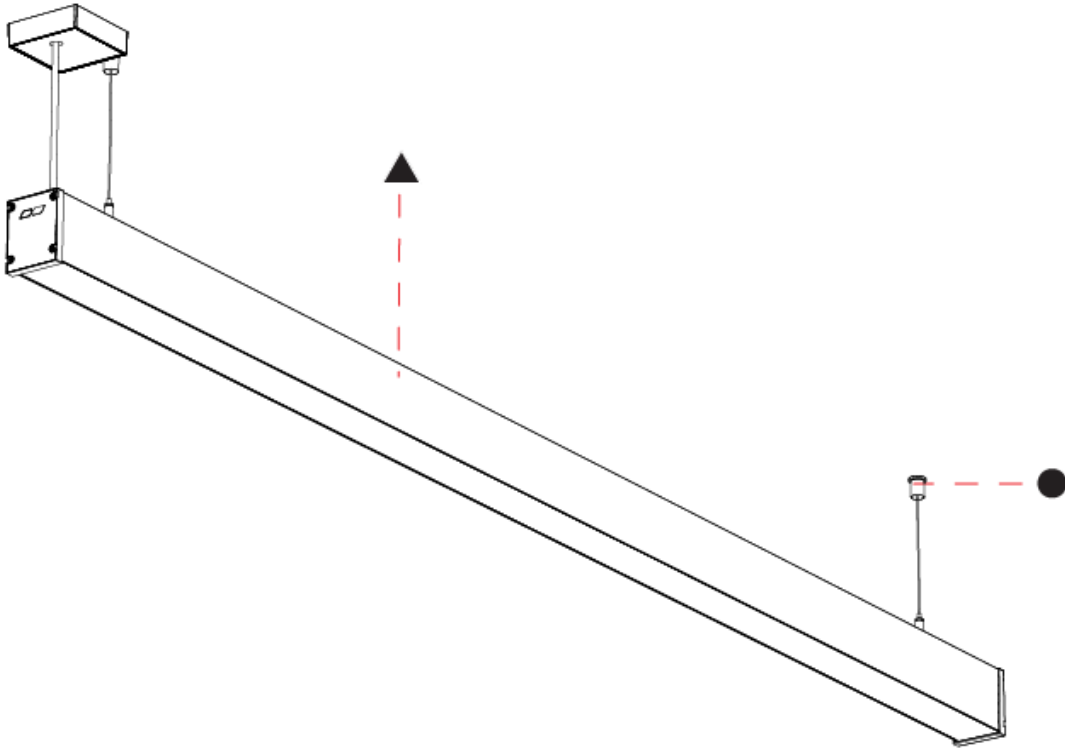

A

PROJECT	_____
TYPE	_____
SPECIFIER	_____
QUANTITY	_____
DATE	_____

## SLIDER STRAIGHT IP54 SURFACE

### A3D387-

base number	LED Dimming	Color Temperature	Finishes (Diamond)	Finishes (Triangle)	Diffuser Options
-------------	-------------	-------------------	--------------------	---------------------	------------------

- To build a product code in our configurator select the specify button on the base model # product page
- To build a manual product code on this datasheet choose from the options listed below in blue font and add the suffix to the base model #

#### GENERAL

Series: Slider Straight IP54
Partner: Prolicht
Division: Architectural
Installation: Surface
Product Type: Linear Profiles
Mounting Location: Ceiling
Light Distribution: Direct

#### PHYSICAL

Shape: Rectangle
Length (mm): 1410
Length (in): 55 1/2
Width (mm): 65
Width (in): 2 9/16
Height (mm): 80
Height (in): 3 1/8
Weight (kg): 2.420

Diffuser: [Diffuser - Opal](#), [Micro-prism](#), [Clear Micro-prism](#), [Glare Control](#), [Wallwasher Right](#), [Wallwasher Left](#), [Wallwash Double Asymmetric](#)

Fixture Finish: [SSR / BKV / CWI / CRY / HAB / UFT / ITA / RUA / FTG / MYG / LOD / PUS / FRO / FUP / KIA / POP / BLS / SPG / MEY / GOH / CHC / COM / ABZ / JAG / OBR / MOS / ROR](#)

Fixture Material: Aluminum Die Cast

#### ELECTRICAL

Lamp Type: LED (Zhaga Standard)
Input Wattage (W): 30
Total Output Wattage (W): 27.3
<a href="#">Dimming: Non-Dimmable</a>
Driver Included: No
Driver Location: Remote
Driver Class: Class 2
Input Voltage (V): 120
Upon Request: DALI Dimming, MATTER Dimming

#### LED

<a href="#">Color Temperature (°K): 2700 / 3000 / 3500 / 4000</a>
Max. Delivered Lumen (lm): 3097 - 4306
Nominal Lumen (lm): 4780 - 4990
CRI: >90 CRI
Lamp Life (hrs): 50000

#### OPTICAL

#### RATINGS AND CERTIFICATIONS

Certified By: Certified for North American Standards
IP rating: IP54

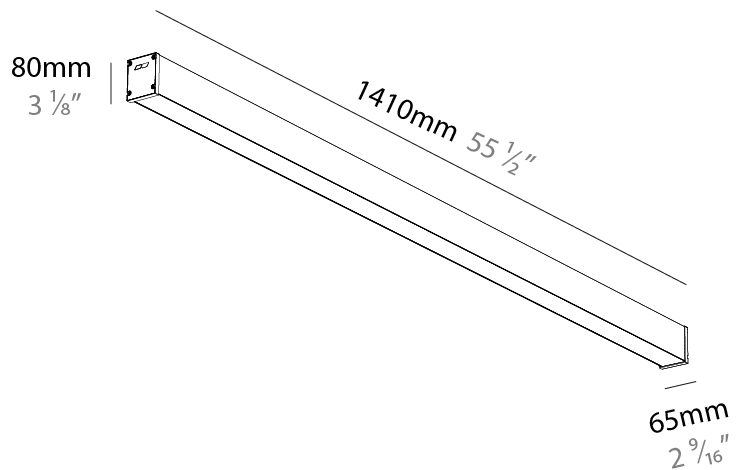

## SLIDER STRAIGHT IP54 SURFACE

A3D387-

PROJECT

TYPE

SPECIFIER

QUANTITY

DATE

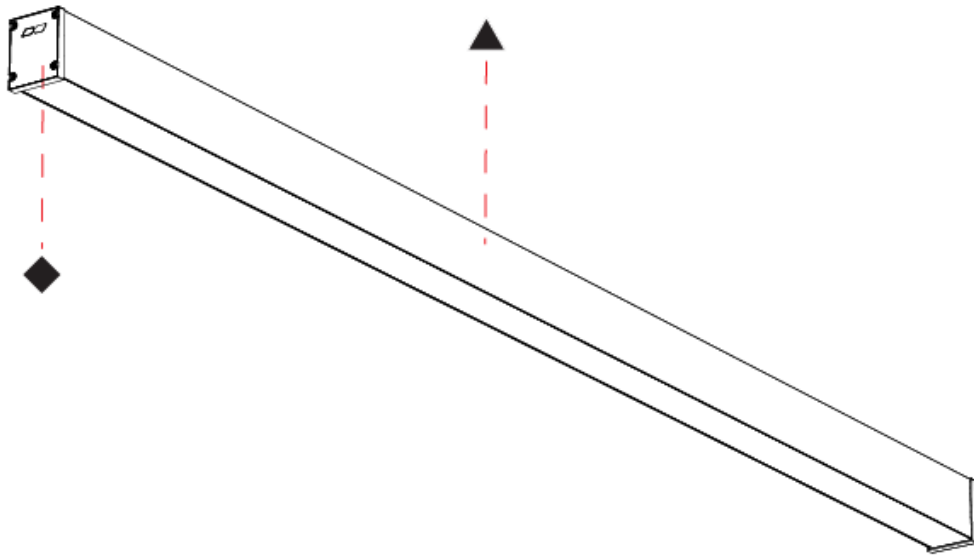

A

PROJECT
TYPE
SPECIFIER
QUANTITY
DATE

## SLIDER STRAIGHT IP54 SURFACE

### A3D388-

base number	LED Dimming	Color Temperature	Finishes (Diamond)	Finishes (Triangle)	Diffuser Options
-------------	-------------	-------------------	--------------------	---------------------	------------------

- To build a product code in our configurator select the specify button on the base model # product page
- To build a manual product code on this datasheet choose from the options listed below in blue font and add the suffix to the base model #

#### GENERAL

Series: Slider Straight IP54
Partner: Prolicht
Division: Architectural
Installation: Surface
Product Type: Linear Profiles
Mounting Location: Ceiling
Light Distribution: Direct

#### PHYSICAL

Shape: Rectangle
Length (mm): 1610
Length (in): 63 <sup>3</sup> / <sub>8</sub>
Width (mm): 65
Width (in): 2 <sup>9</sup> / <sub>16</sub>
Height (mm): 80
Height (in): 3 <sup>1</sup> / <sub>8</sub>
Weight (kg): 2.420

Diffuser: [Diffuser - Opal](#), [Micro-prism](#), [Clear Micro-prism](#), [Glare Control](#), [Wallwasher Right](#), [Wallwasher Left](#), [Wallwash Double Asymmetric](#)

Fixture Finish: [SSR / BKV / CWI / CRY / HAB / UFT / ITA / RUA / FTG / MYG / LOD / PUS / FRO / FUP / KIA / POP / BLS / SPG / MEY / GOH / CHC / COM / ABZ / JAG / OBR / MOS / ROR](#)

Fixture Material: Aluminum Die Cast

#### ELECTRICAL

Lamp Type: LED (Zhaga Standard)
Input Wattage (W): 34
Total Output Wattage (W): 30.9
<a href="#">Dimming: Non-Dimmable</a>
Driver Included: No
Driver Location: Remote
Driver Class: Class 2
Input Voltage (V): 120
Upon Request: DALI Dimming, MATTER Dimming

#### LED

<a href="#">Color Temperature (°K): 2700 / 3000 / 3500 / 4000</a>
Max. Delivered Lumen (lm): 3538 - 4919
Nominal Lumen (lm): 5460 - 5700
CRI: >90 CRI
Lamp Life (hrs): 50000

#### OPTICAL

#### RATINGS AND CERTIFICATIONS

Certified By: Certified for North American Standards
IP rating: IP54

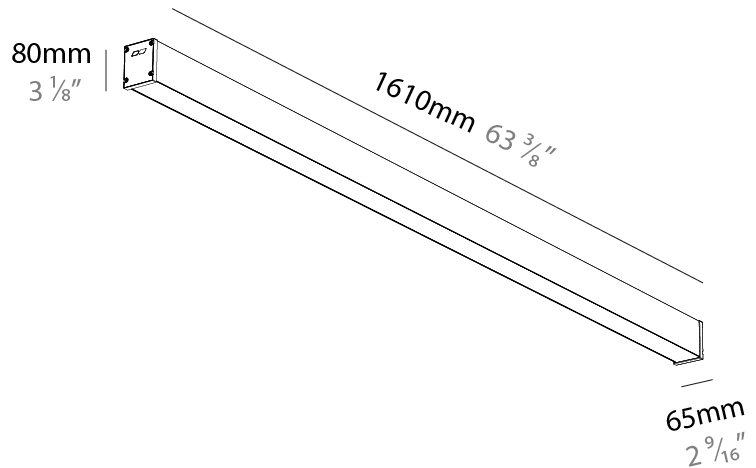

## SLIDER STRAIGHT IP54 SURFACE

A3D388-

PROJECT

TYPE

SPECIFIER

QUANTITY

DATE

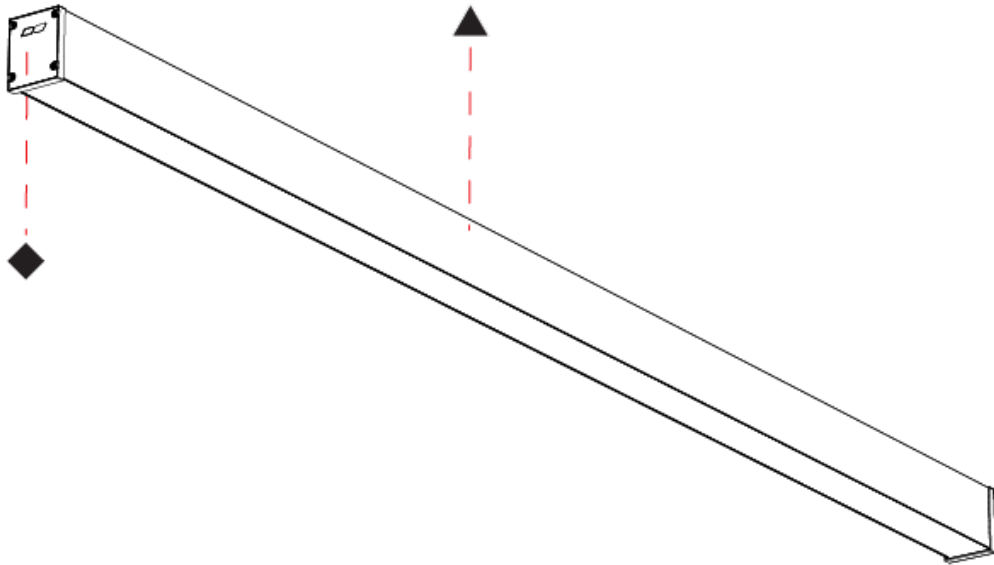

A

PROJECT	_____
TYPE	_____
SPECIFIER	_____
QUANTITY	_____
DATE	_____

## SLIDER STRAIGHT IP54 SURFACE

### A3D389-

base number	LED Dimming	Color Temperature	Finishes (Diamond)	Finishes (Triangle)	Diffuser Options
-------------	-------------	-------------------	--------------------	---------------------	------------------

- To build a product code in our configurator select the specify button on the base model # product page
- To build a manual product code on this datasheet choose from the options listed below in blue font and add the suffix to the base model #

#### GENERAL

Series: Slider Straight IP54
Partner: Prolicht
Division: Architectural
Installation: Surface
Product Type: Linear Profiles
Mounting Location: Ceiling
Light Distribution: Direct

#### PHYSICAL

Shape: Rectangle
Length (mm): 1810
Length (in): 71 1/4
Width (mm): 65
Width (in): 2 9/16
Height (mm): 80
Height (in): 3 1/8
Weight (kg): 2.420

Diffuser: [Diffuser - Opal](#), [Micro-prism](#), [Clear Micro-prism](#), [Glare Control](#), [Wallwasher Right](#), [Wallwasher Left](#), [Wallwash Double Asymmetric](#)

Fixture Finish: [SSR / BKV / CWI / CRY / HAB / UFT / ITA / RUA / FTG / MYG / LOD / PUS / FRO / FUP / KIA / POP / BLS / SPG / MEY / GOH / CHC / COM / ABZ / JAG / OBR / MOS / ROR](#)

Fixture Material: Aluminum Die Cast

#### ELECTRICAL

Lamp Type: LED (Zhaga Standard)
Input Wattage (W): 39
Total Output Wattage (W): 35.5
<a href="#">Dimming: Non-Dimmable</a>
Driver Included: No
Driver Location: Remote
Driver Type: Constant Current - Universal
Driver Class: Class 2
Input Voltage (V): 120
Constant Current (MA): 300mA
Upon Request: DALI Dimming, MATTER Dimming

#### LED

<a href="#">Color Temperature (°K): 2700 / 3000 / 3500 / 4000</a>
Max. Delivered Lumen (lm): 3985 - 5540
Nominal Lumen (lm): 6150 - 6420
CRI: >90 CRI
Lamp Life (hrs): 50000

#### OPTICAL

#### RATINGS AND CERTIFICATIONS

Certified By: Certified for North American Standards
IP rating: IP54

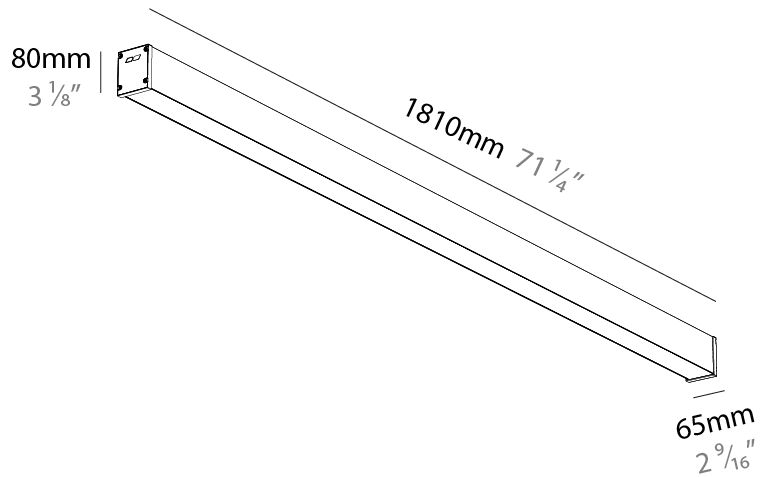

## SLIDER STRAIGHT IP54 SURFACE

A3D389-

PROJECT

TYPE

SPECIFIER

QUANTITY

DATE

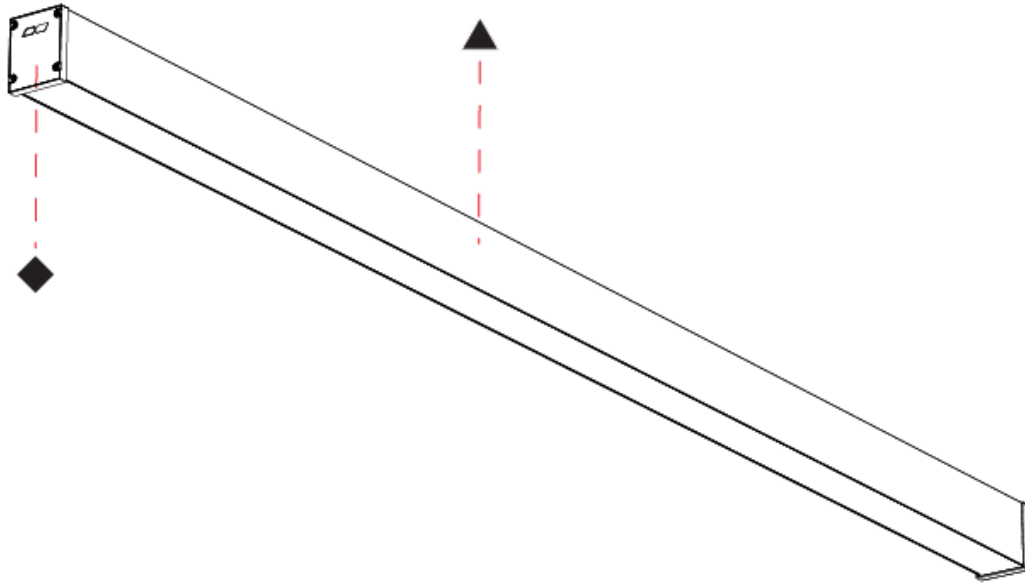

## SLIDER STRAIGHT IP54 COLOR FINISH CHART

PROJECT
TYPE
SPECIFIER
QUANTITY
DATE

### Fixture Finish

Sparkling Silver - 01 (SSR) 	Black Velvet - 02 (BKV) 	Crystal White - 03 (CWI) 	Creamy - 04 (CRY) 	Hampton Bay - 05 (HAB) 	Urban Forest - 07 (UFT) 
In the Army - 08 (ITA) 	Rusty Angel - 09 (RUA) 	Fade to Gray - 12 (FTG) 	Mysterious Gray - 13 (MYG) 	Lost Dream - 15 (LOD) 	Purple Sky - 16 (PUS) 
Fresh Oh - 17 (FRO) 	Funky P. - 18 (FUP) 	Kissing Aphrodite - 19 (KIA) 	Poseidon's Paradise - 20 (POP) 	Blue Sky - 21 (BLS) 	Spring Green - 22 (SPG) 
Mellow Yellow - 23 (MEY) 	Golden Heart - 24 (GOH) 	Champagne Cream - 26 (CHC) 	Copper Mine - 27 (COM) 	Ancient Bronze - 28 (ABZ) 	Jazz Gold - 29 (JAG) 
Olive Breeze - 30 (OBR) 	Moonlight Silver - 31 (MOS) 	Rosewood Red - 32 (ROR) 			





































































**Digital:** Not all screens are calibrated the same, and therefore, colors will appear differently between screens.

**Physical:** When texture is involved, there will be variations in color, character and tone within a product series and between product families.











**Champagne Cream, Copper Mine, Ancient Bronze + Jazz Gold:** These finishes have slight fading from specific powder coating production. Each luminaire will slightly vary.













### LEGEND

 floor-mounted	 pivotable	 special LED (upon request) RGB, RGBW, tunable, gold+, meat+, art+, fashion+
 wall and ceiling: recessed and surface mounted	 rotating	 warm dim / natural dimming LED
 ceiling-mounted and wall-mounted	 illuminate tilted	 rechargeable battery powered
 wall-mounted	 color of suspension cable	 fixture with natural vivid LED (upon request)
 omni-directional light distribution	 length of suspension cable	 color rendering index
 direct light distribution	 reflector degree selection	 color temperature
 direct/indirect light distribution	 super spot	 lumen (luminous flux)
 indirect light distribution	 lens	 efficacy (lumens per watt)
 asymmetric light distribution	 lens pack	 Unified Glare Rating (UGR) range from 5-40
 aura light distribution	 shine ring	 marine grade (AISI 316 stainless steel)
 round wall or ceiling cut-out	 integrated shine ring with diffuser	 walk on
 square wall or ceiling cut-out	 free individual colors 01-29	 drive on
 the supplied jig specifies the cutout dimensions	 individual colors: 00 (free of charge), 01-25 (extra charge)	 Dark Sky Compliance
 minimum distance (meters) lamp - object	 luminaire part to be colored (F1)	 Americans with Disabilities Act (less than 4" off the wall located between 27"-84" from floor)
 recessed depth	 luminaire part to be colored (F2)	 lamp protected against explosion
 ceiling thickness in mm	 luminaire part to be colored (F3)	 blown glass using traditional methods by master glass blower
 ceiling thickness selection	 luminaire part to be colored (F4)	 acoustic material
 dimmable DP (phase), DV (0-10V), DD (dali), DS (step-dim)	 luminaire part to be colored (F5)	 protection class I, protection insulation
 included or excluded LED driver/transformer/control gear	 color of 3-circuit adaptor	 protection class II, protection insulation
 separately switchable	 indirect diffuser	 ETL Certified to UL and CSA Standards
 sensor	 direct diffuser	 UL Certified to UL and CSA Standards
 remote control	 ball-proof (upon request)	 CSA Certified to UL and CSA Standards
 available upon request	 accessory	 Certified for North American Standards

### IP RATING

 IP20	protected against ingress of solid bodies greater than 12.5mm (finger)
 IP33	protected against ingress of solid bodies greater than 2.5mm protected against sprays of water up to 60 degrees from the vertical (rain)
 IP40	protected against ingress of solid bodies greater than 1mm (wire) no protection against the ingress of moisture
 IP43	protected against ingress of solid bodies greater than 1mm (wire) protected against sprays of water up to 60 degrees from the vertical (rain)
 IP44	protected against ingress of solid bodies greater than 1mm (wire) protected against water splashed from all directions
 IP54	protected against limited ingress of dust (wet rooms/covered outdoor areas) protected against water splashed from all directions
 IP65	protected against ingress of dust protected against jets of water
 IP66	protected against ingress of dust protected against powerful jets of water or heavy seas
 IP67	protected against ingress of dust protected against immersion of water between 15cm - 1m for 30 minutes
 IP68	protected against ingress of dust protected against immersion of water under pressure for long periods

### IK RATING

 IK01	protected against 0.14 joules impact (equivalent to 0.25kg mass dropped from 56mm above the surface)
 IK02	protected against 0.2 joules impact (equivalent to 0.25kg mass dropped from 80mm above the surface)
 IK03	protected against 0.35 joules impact (equivalent to 0.25kg mass dropped from 140mm above the surface)
 IK04	protected against 0.5 joules impact (equivalent to 0.25kg mass dropped from 200mm above the surface)
 IK05	protected against 0.7 joules impact (equivalent to 0.25kg mass dropped from 280mm above the surface)
 IK06	protected against 1 joules impact (equivalent to 0.25kg mass dropped from 400mm above the surface)
 IK07	protected against 2 joules impact (equivalent to 0.5kg mass dropped from 400mm above the surface)
 IK08	protected against 5 joules impact (equivalent to 1.7kg mass dropped from 300mm above the surface)
 IK09	protected against 10 joules impact (equivalent to 5.0kg mass dropped from 200mm above the surface)
 IK10	protected against 20 joules impact (equivalent to 5.0kg mass dropped from 400mm above the surface)